

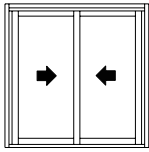

Capítulo 3

Tipología

JANELA 2 FOLHAS



JANELA 3 FOLHAS

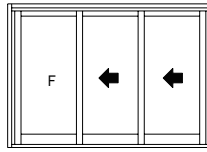

JANELA 4 FOLHAS

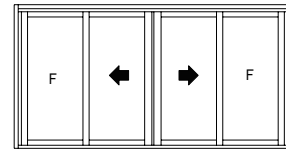

JANELA 2 FOLHAS C/ BANDEIRA MÓVEL

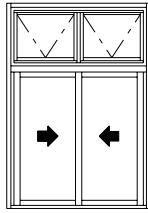

JANELA 4 FOLHAS C/ PEITORIL FIXO

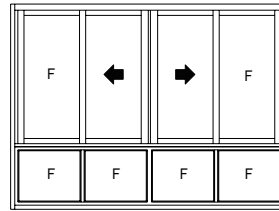

JANELA 3 FOLHAS

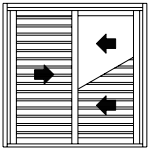

JANELA 4 FOLHAS

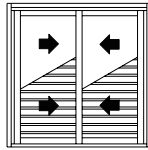

JANELA CAMARÃO

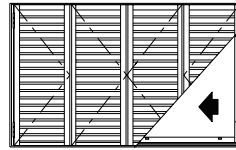

JANELA 6 FOLHAS

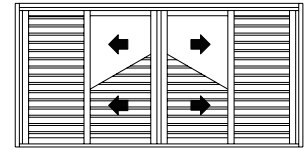

PORTA 3 FOLHAS

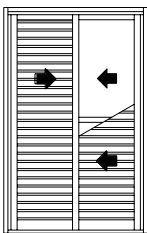

PORTA 2 FOLHAS

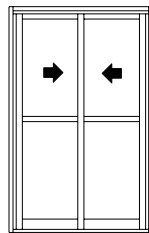

PORTA 4 FOLHAS

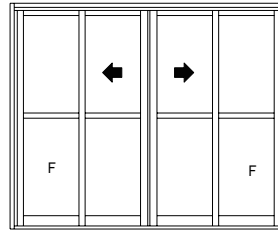

PORTA 3 FOLHAS

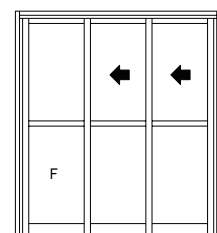

JANELA MAXIM-AR 1 FOLHA

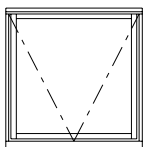

JANELA MAXIM-AR 2 FOLHAS

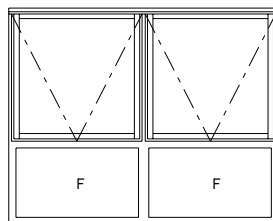

PORTA 1 FOLHAS

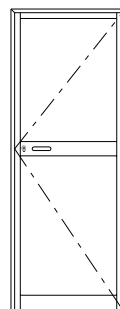

PORTA 2 FOLHAS

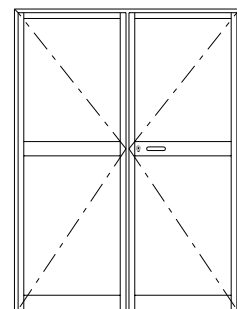



Capítulo 4

Diagramas de dimensões

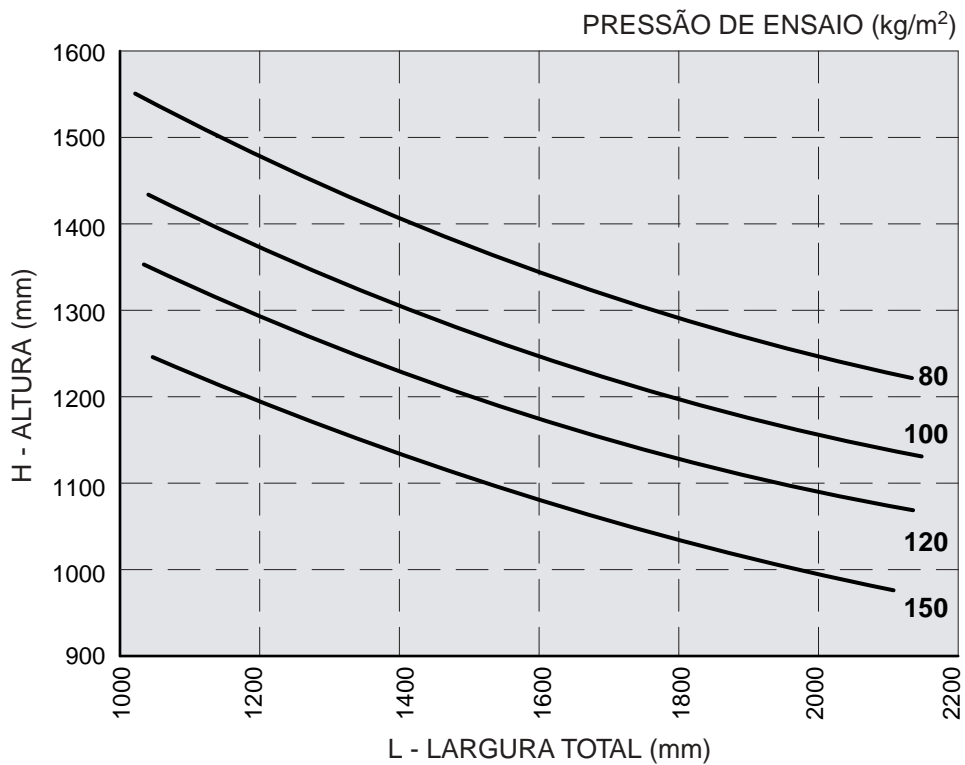
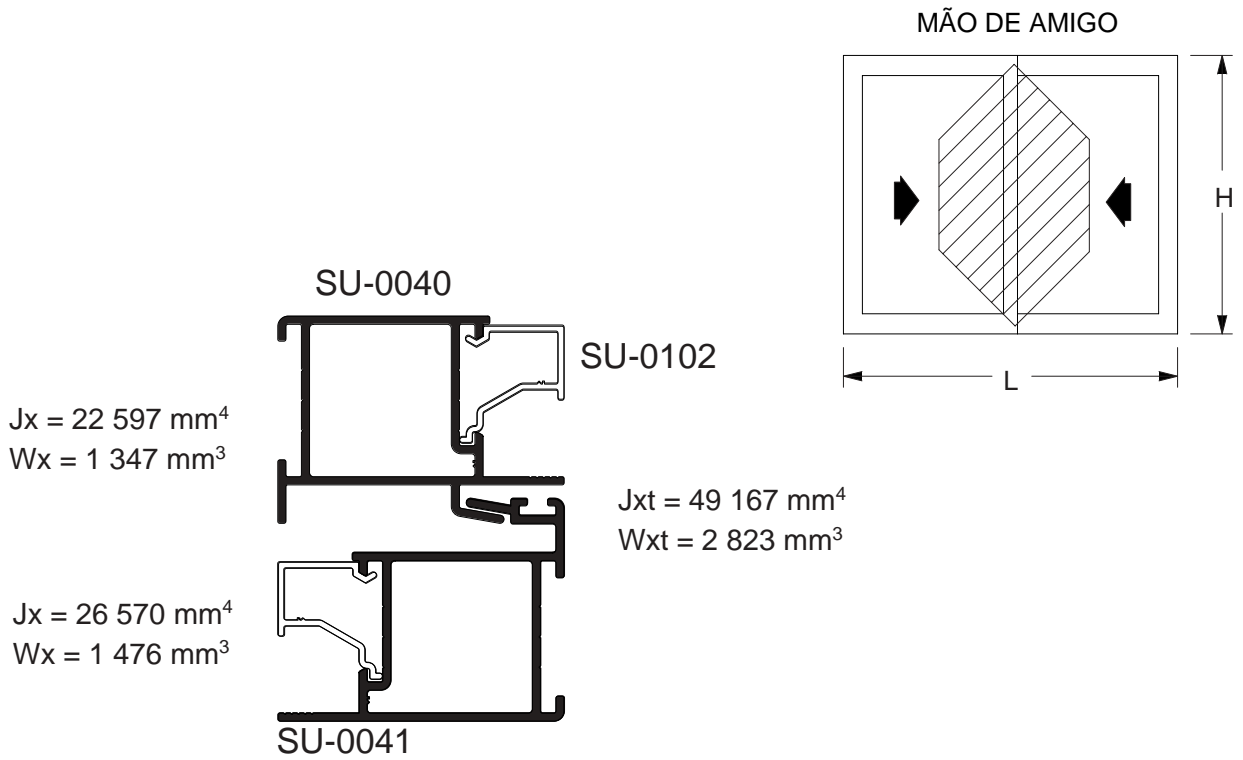

CENTRAL 4 FOLHAS

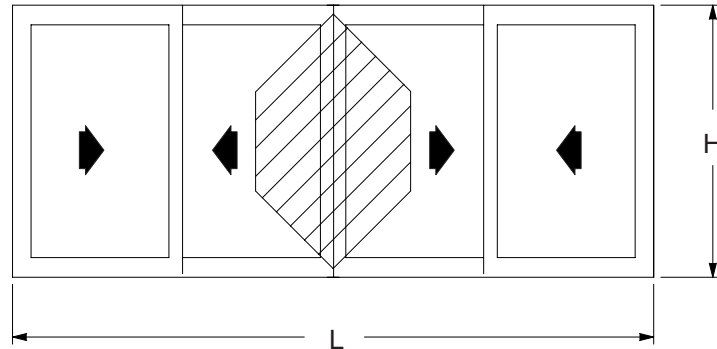

$J_{xt} = 53\,423 \text{ mm}^4$
 $W_{xt} = 3\,951 \text{ mm}^3$

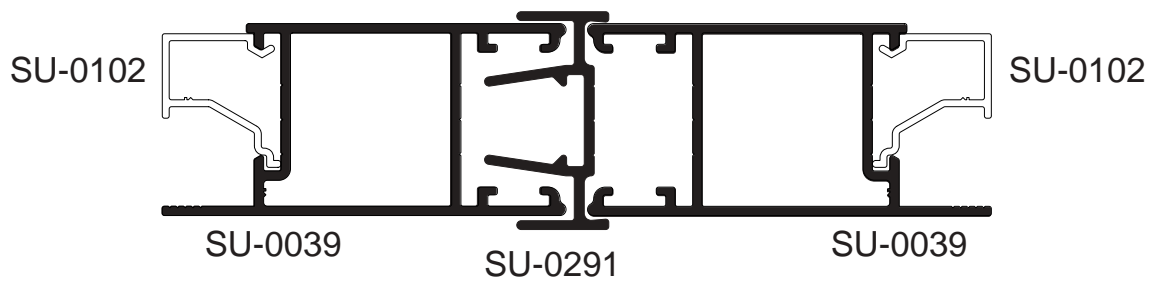

SU-0039/0102

$J_x = 22\,473 \text{ mm}^4$
 $W_x = 1\,791 \text{ mm}^3$

SU-0039/0291/0102

$J_x = 30\,950 \text{ mm}^4$
 $W_x = 2\,160 \text{ mm}^3$

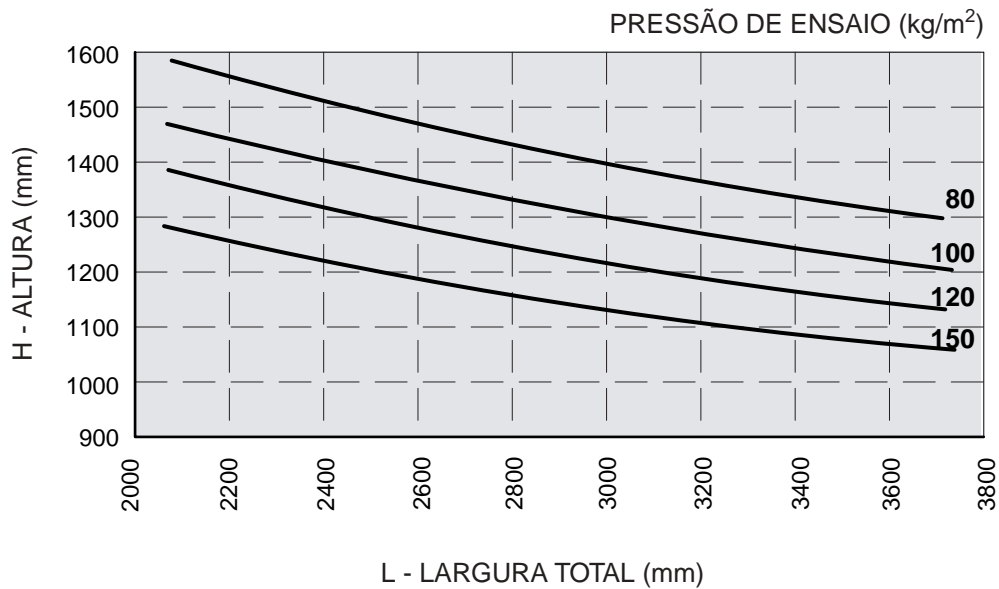

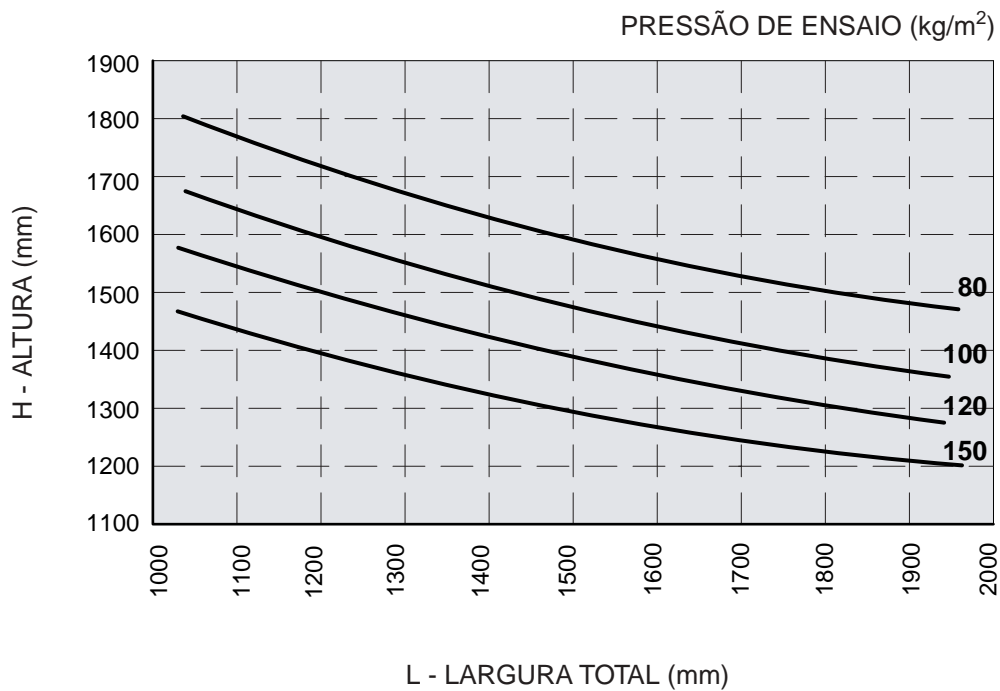
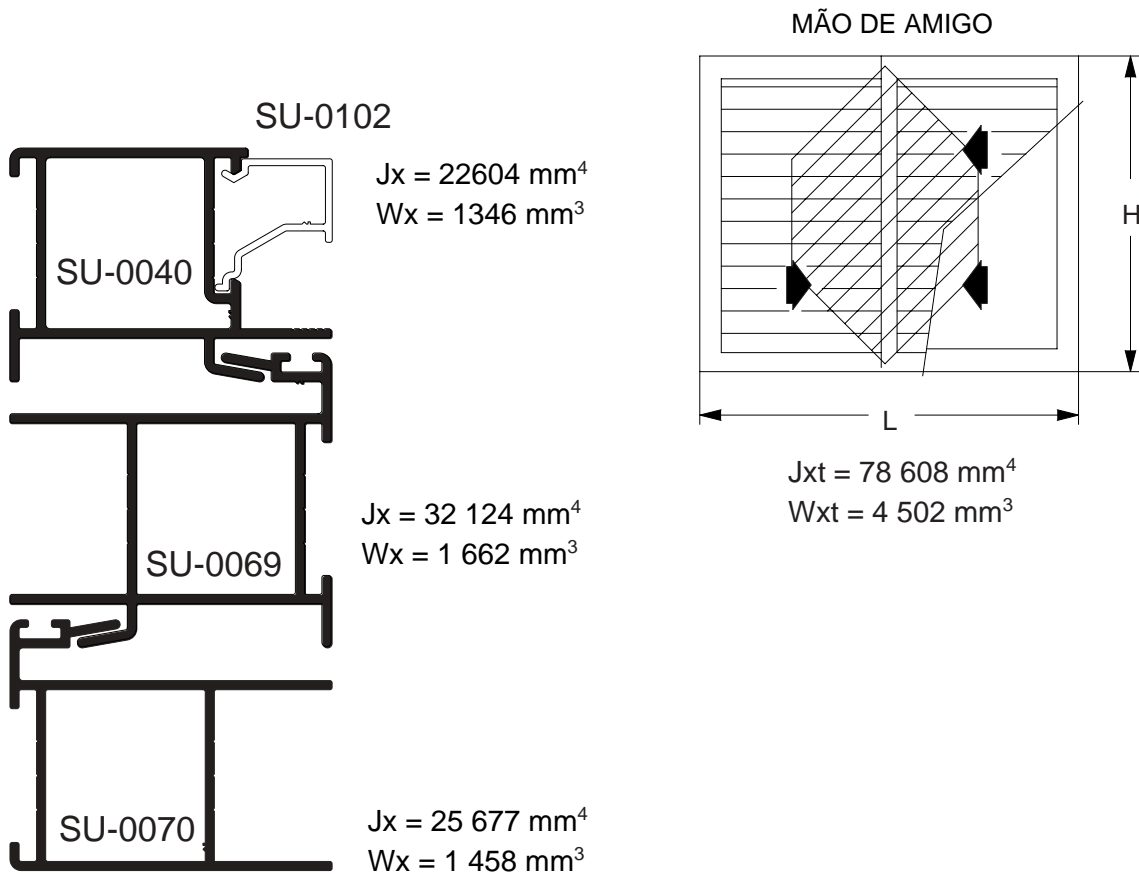

MÃO DE AMIGO

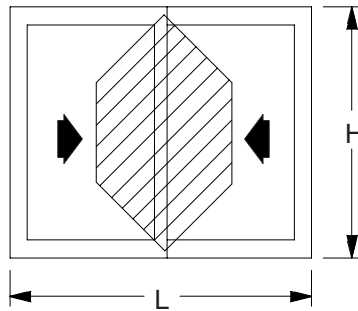

$$Jx = 22604 \text{ mm}^4$$

$$Wx = 1346 \text{ mm}^3$$

MÃO DE AMIGO

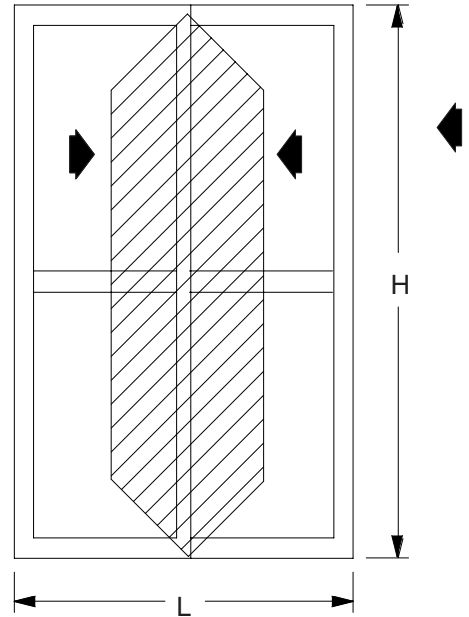

$$Jxt = 259\,283 \text{ mm}^4$$

$$Wxt = 7\,884 \text{ mm}^3$$

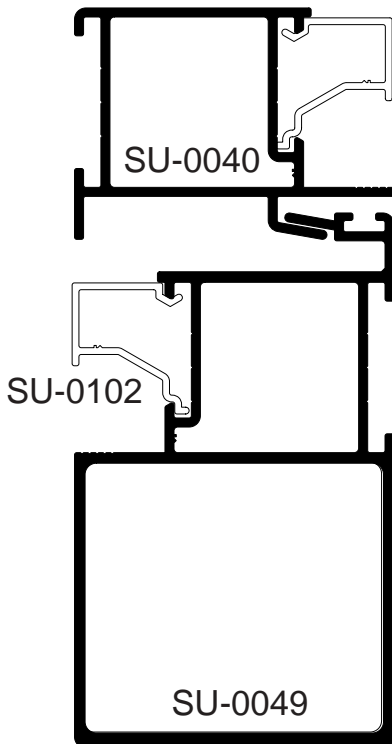

PRESSÃO DE ENSAIO (kg/m²)

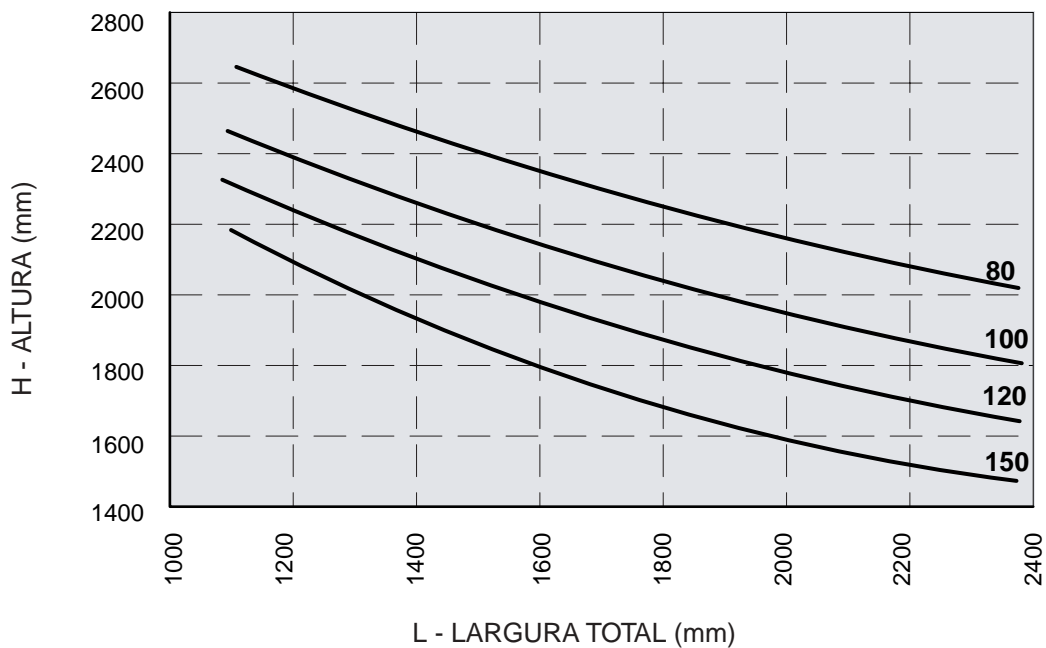

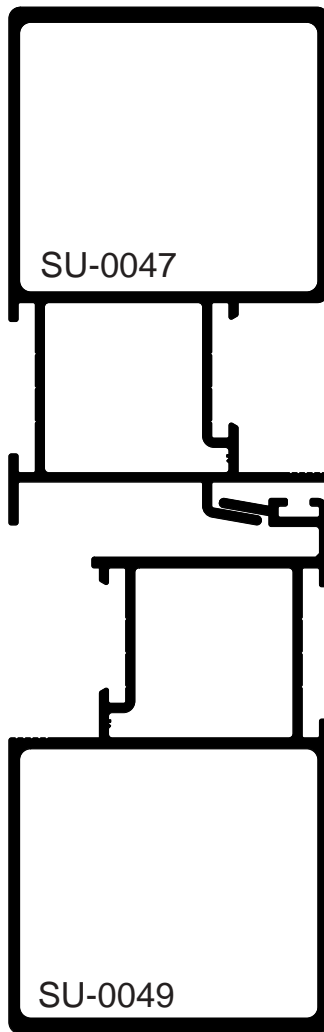

$J_x = 207\ 351\ \text{mm}^4$
 $W_x = 5\ 675\ \text{mm}^3$

$J_x = 217\ 149\ \text{mm}^4$
 $W_x = 5\ 565\ \text{mm}^3$

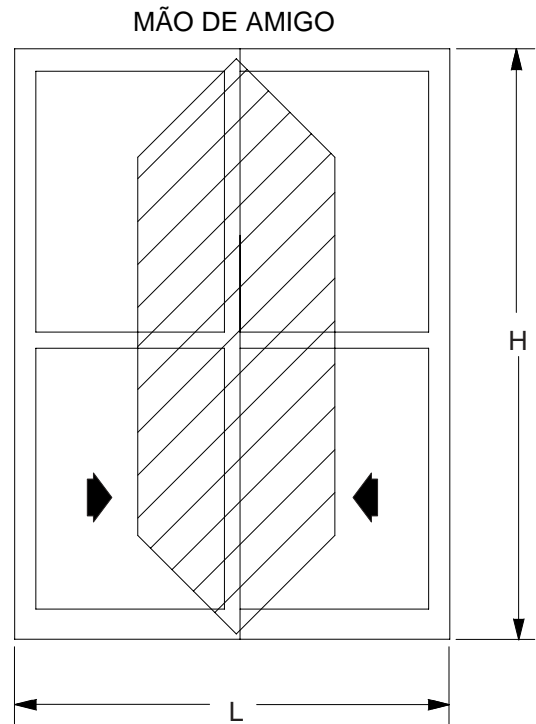

$J_{xt} = 424\ 500\ \text{mm}^4$
 $W_{xt} = 11\ 240\ \text{mm}^3$

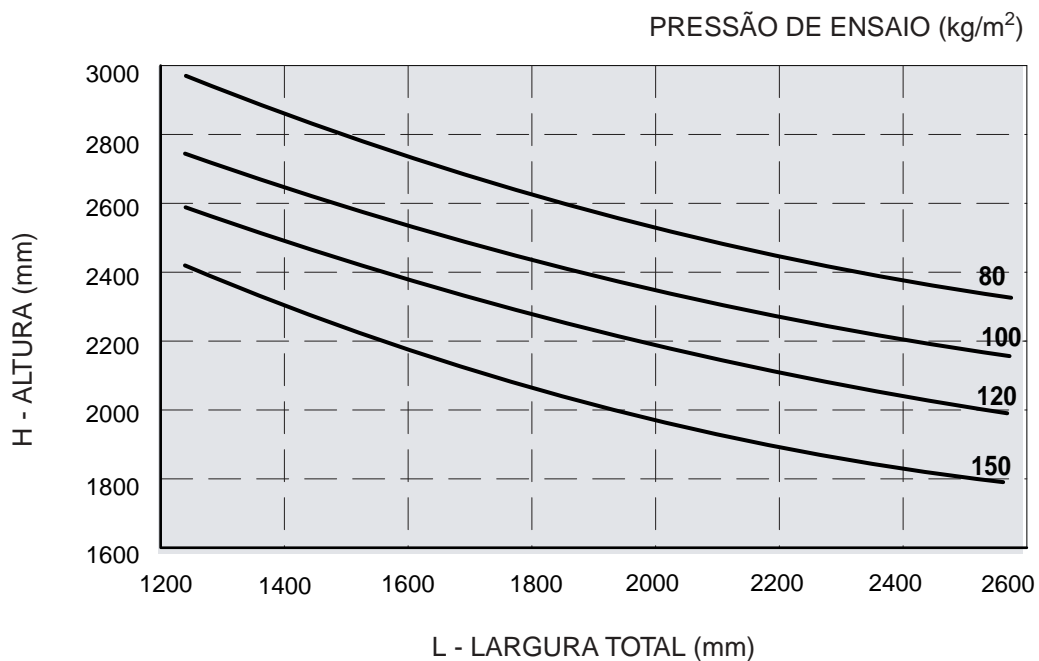

OBS.: Não ultrapassar 70kg por folha.

CENTRAL 4 FOLHAS

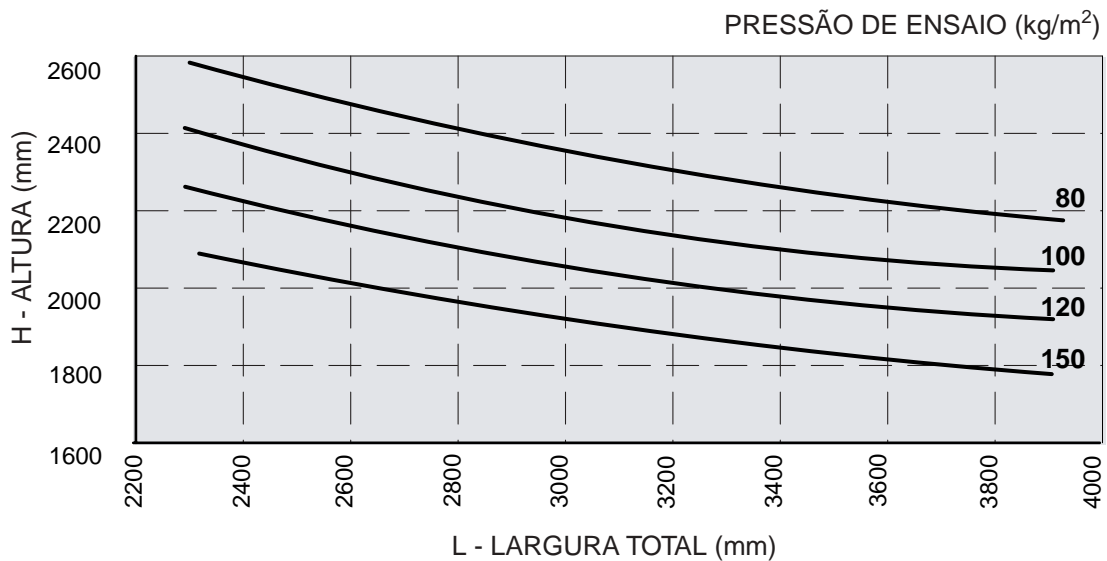
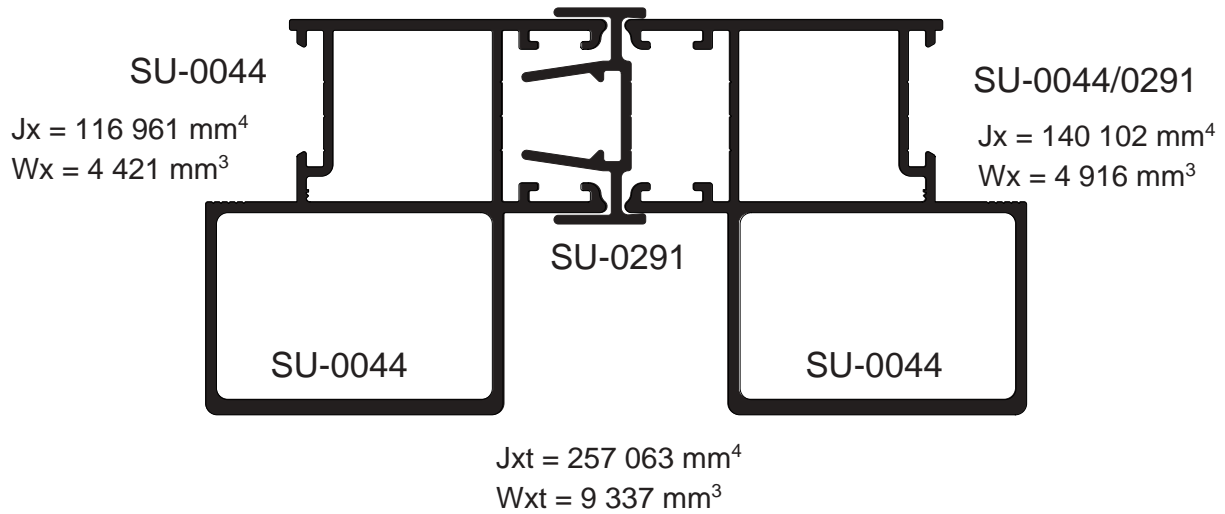
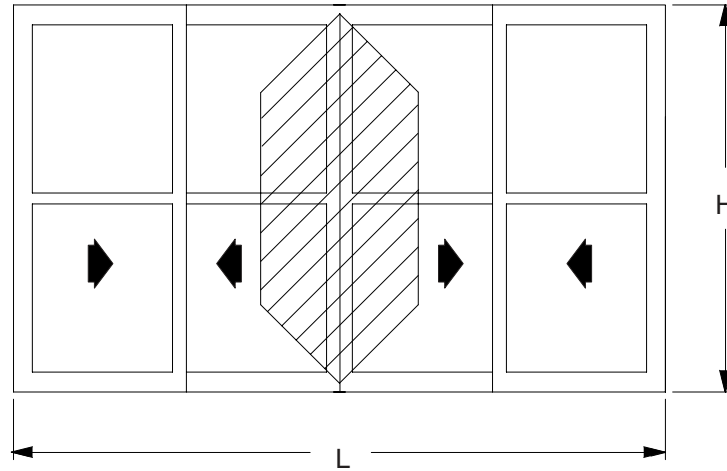

OBS.: Não ultrapassar 70kg por folha.

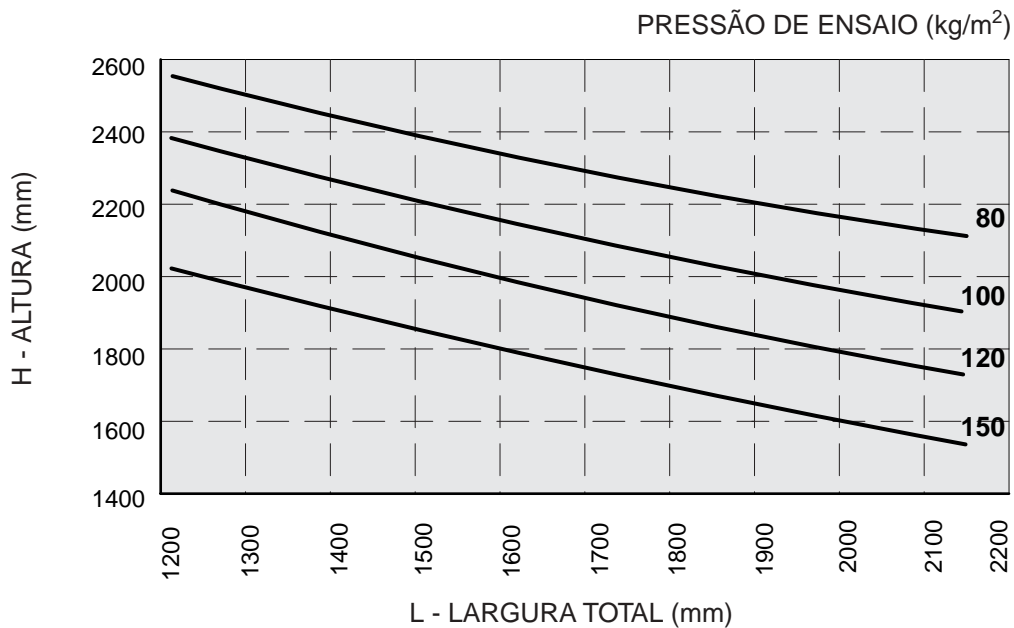
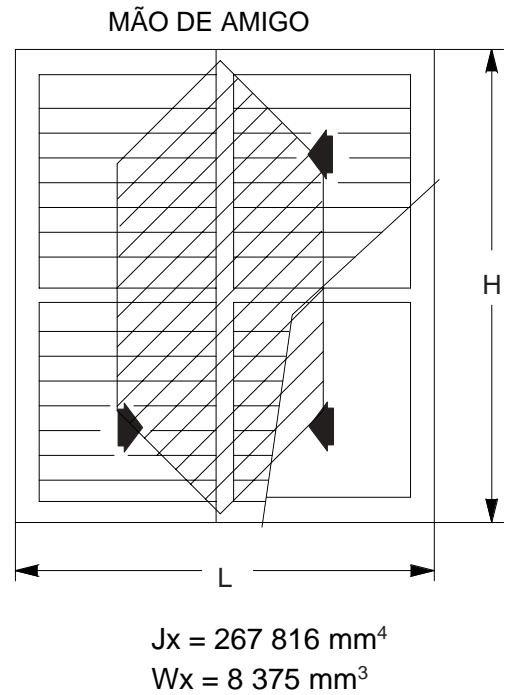
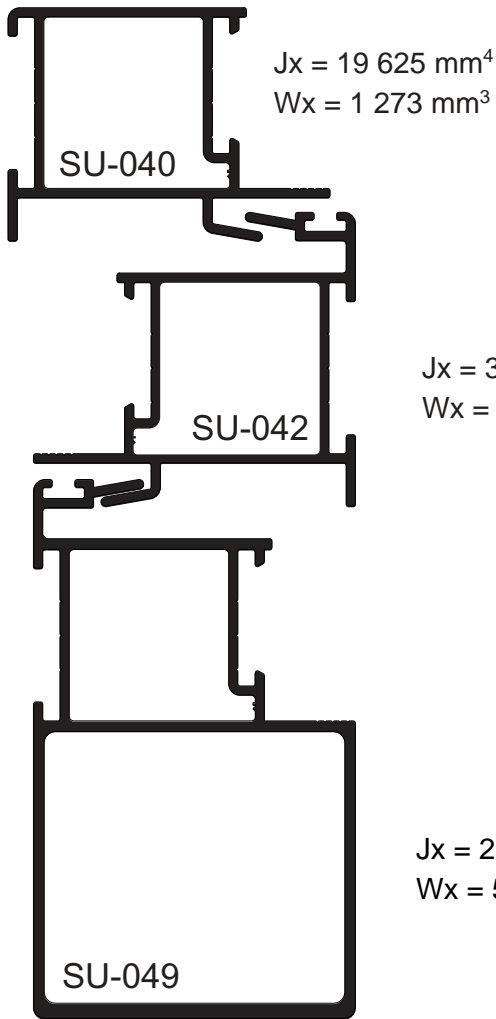

OBS.: Não ultrapassar 70kg por folha.

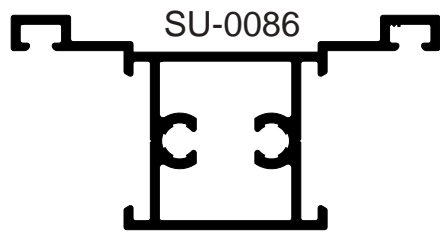

$J_x = 19\,917\text{ mm}^4$
 $W_x = 1\,271\text{ mm}^3$

MONTANTE MAXIM-AR

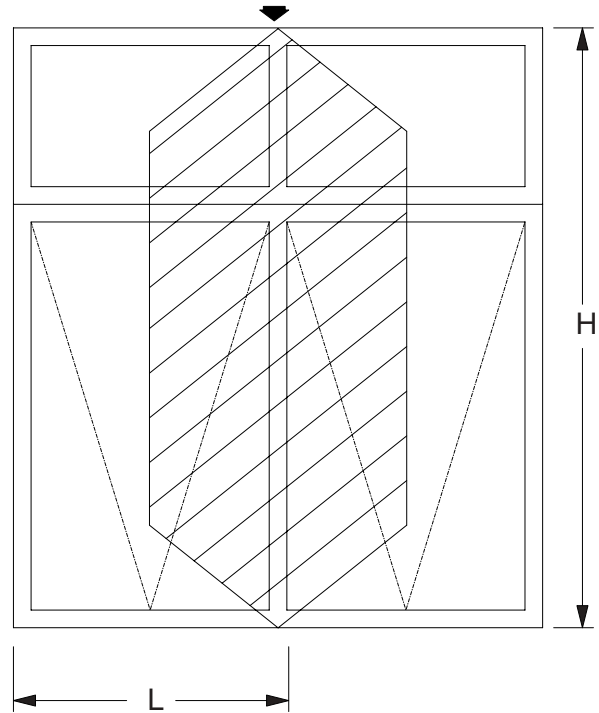

Dimensão máxima da folha móvel 900 x 900mm

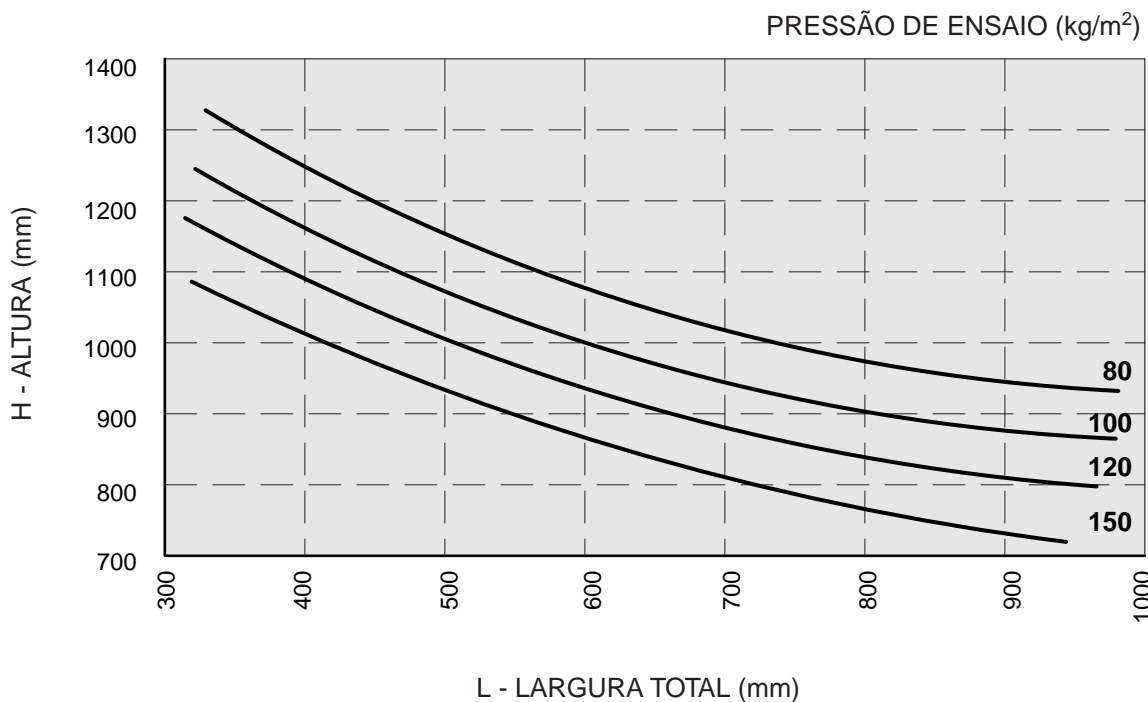

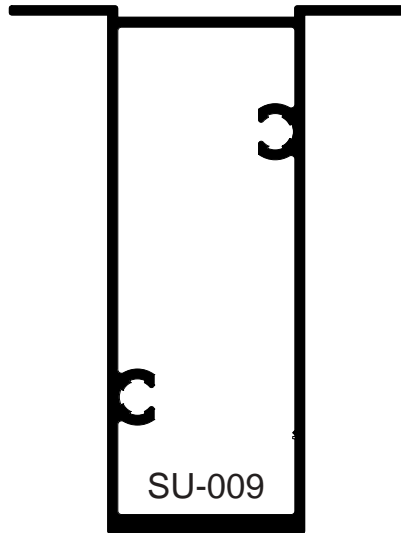

$J_x = 218\,490\text{ mm}^4$
 $W_x = 6\,217\text{ mm}^3$

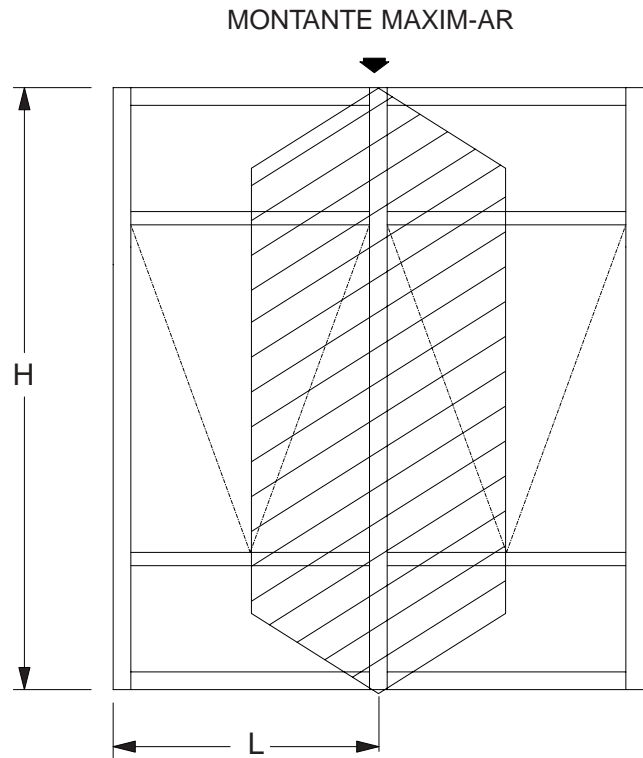

Dimensão máxima da folha móvel 900 x 900mm

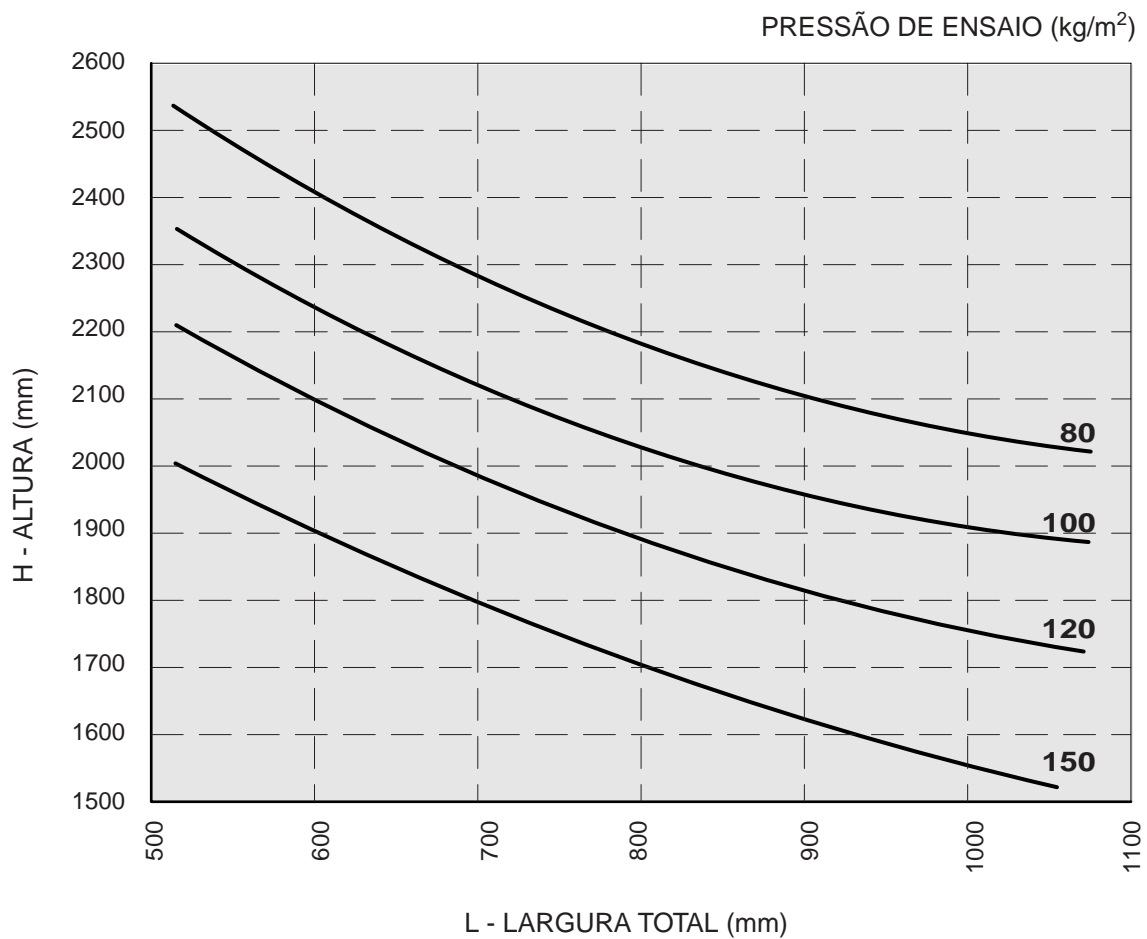

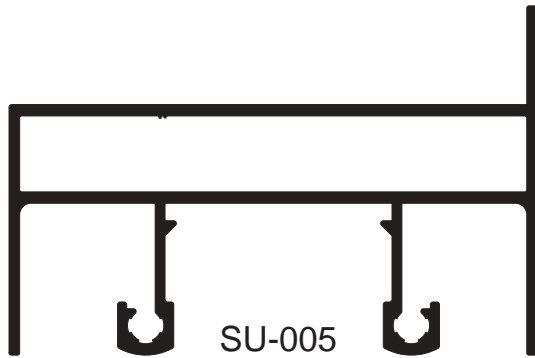

$J_y = 230\,487\text{ mm}^4$
 $W_y = 6\,320\text{ mm}^3$

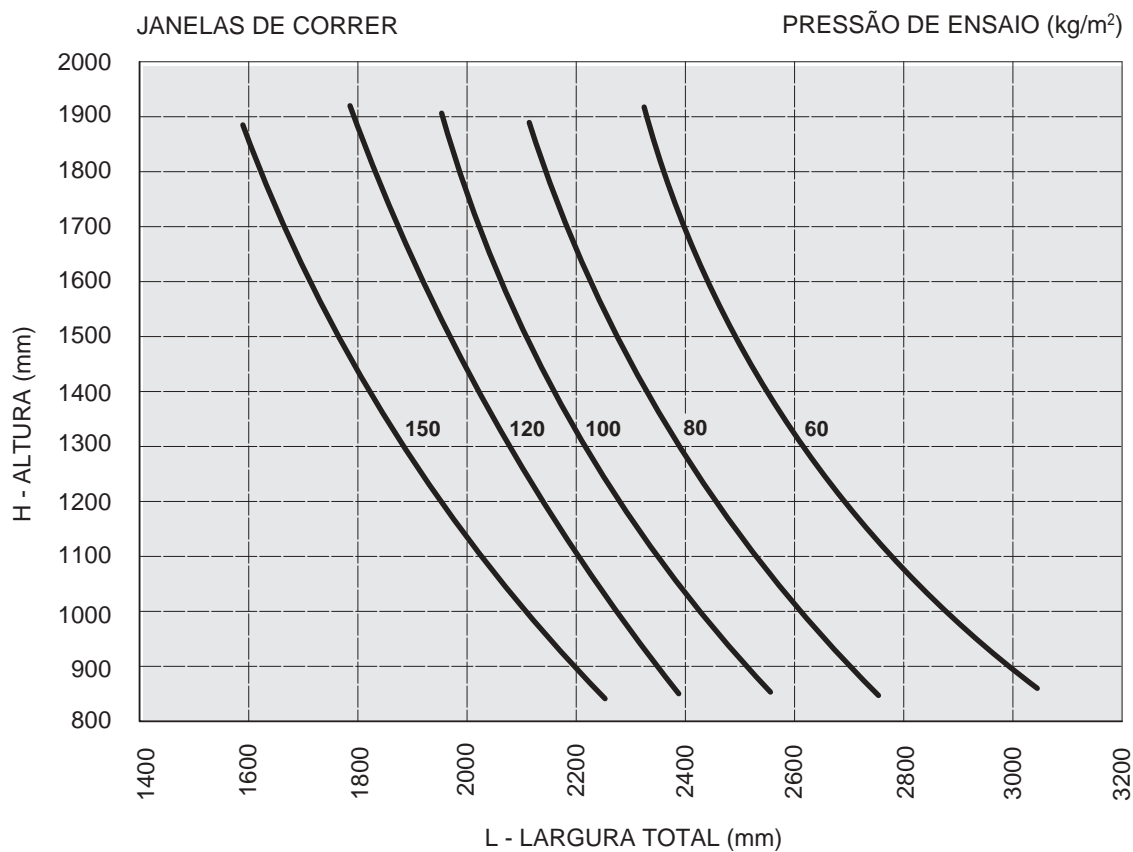
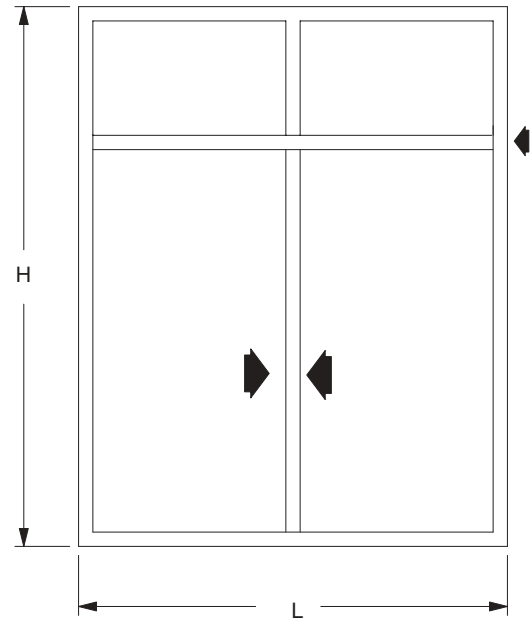

PEITORIL

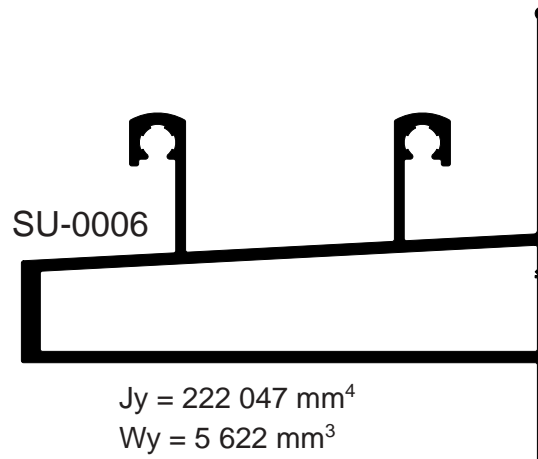
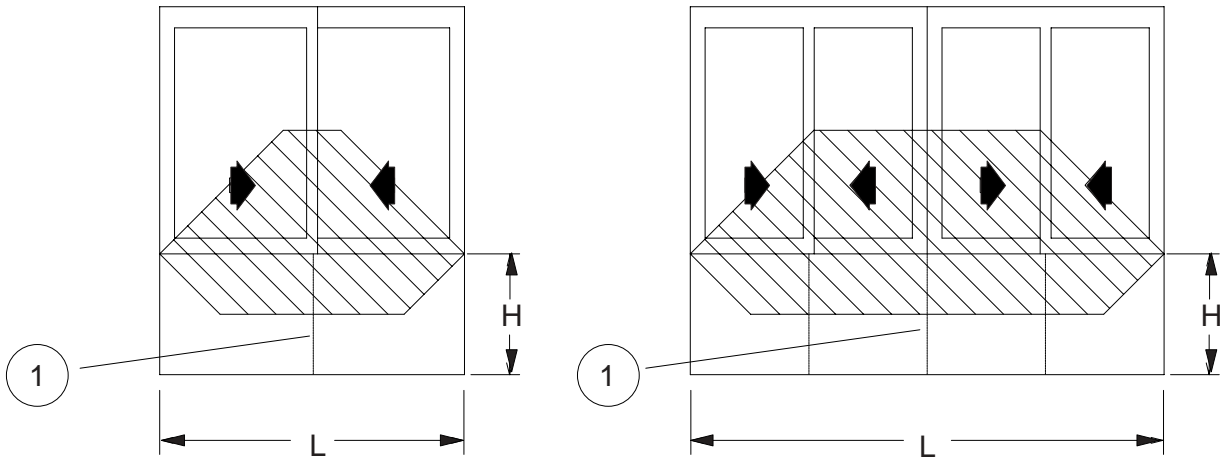

PRESSÃO DE ENSAIO (kg/m²)

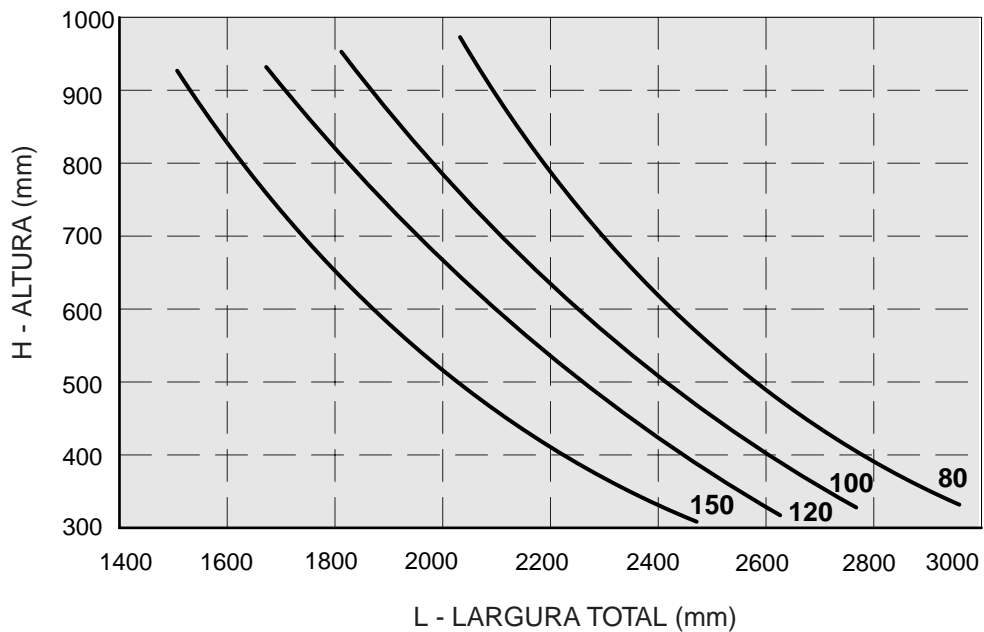

1 Recomendável o uso de montantes para L acima de 1600mm

CENTRAL 4 FOLHAS

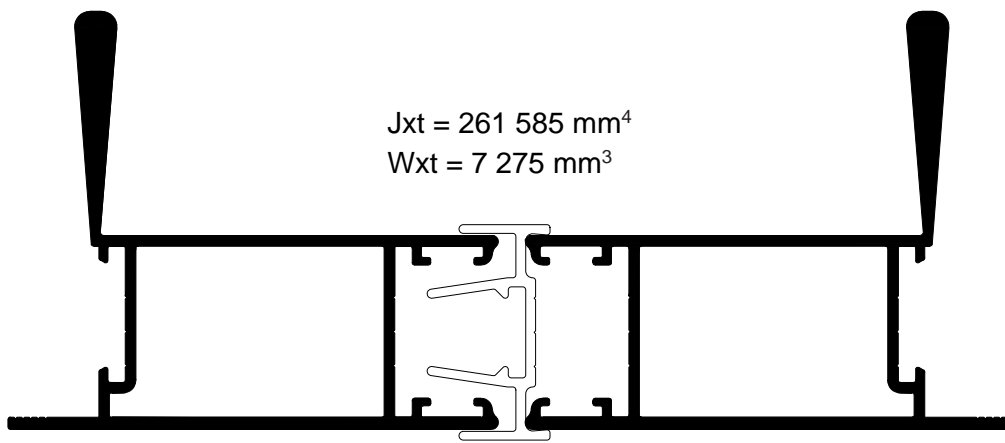
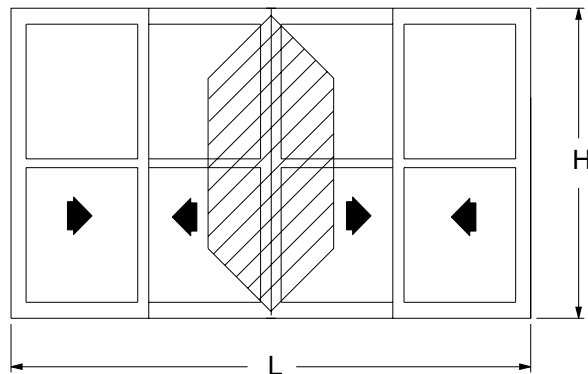

SU-0280

SU-0291

SU-0280/0291

$J_x = 112\ 834\ \text{mm}^4$
 $W_x = 3\ 249\ \text{mm}^3$

$J_x = 148\ 751\ \text{mm}^4$
 $W_x = 4\ 026\ \text{mm}^3$

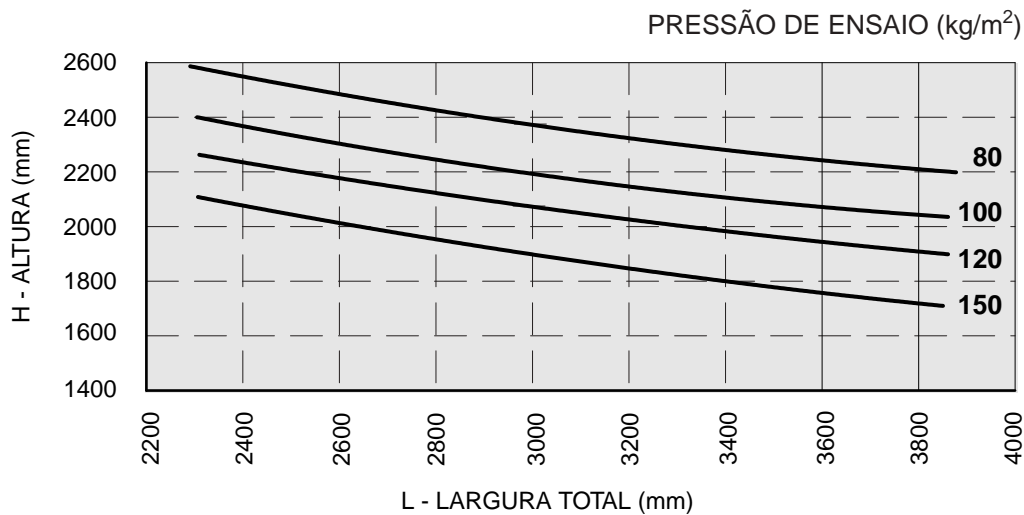

OBS.: Não ultrapassar 70kg por folha.

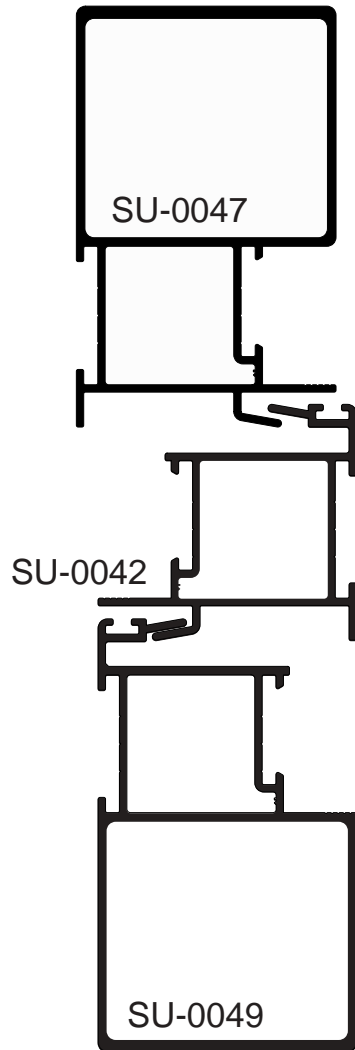

$J_x = 207\,351\text{ mm}^4$
 $W_x = 5\,675\text{ mm}^3$

$J_x = 31\,042\text{ mm}^4$
 $W_x = 1\,537\text{ mm}^3$

$J_x = 217\,149\text{ mm}^4$
 $W_x = 5\,565\text{ mm}^3$

MÃO DE AMIGO

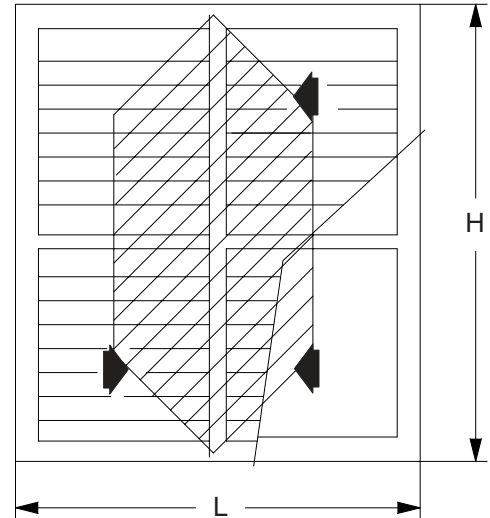

$J_{xt} = 455\,542\text{ mm}^4$
 $W_{xt} = 12\,777\text{ mm}^3$

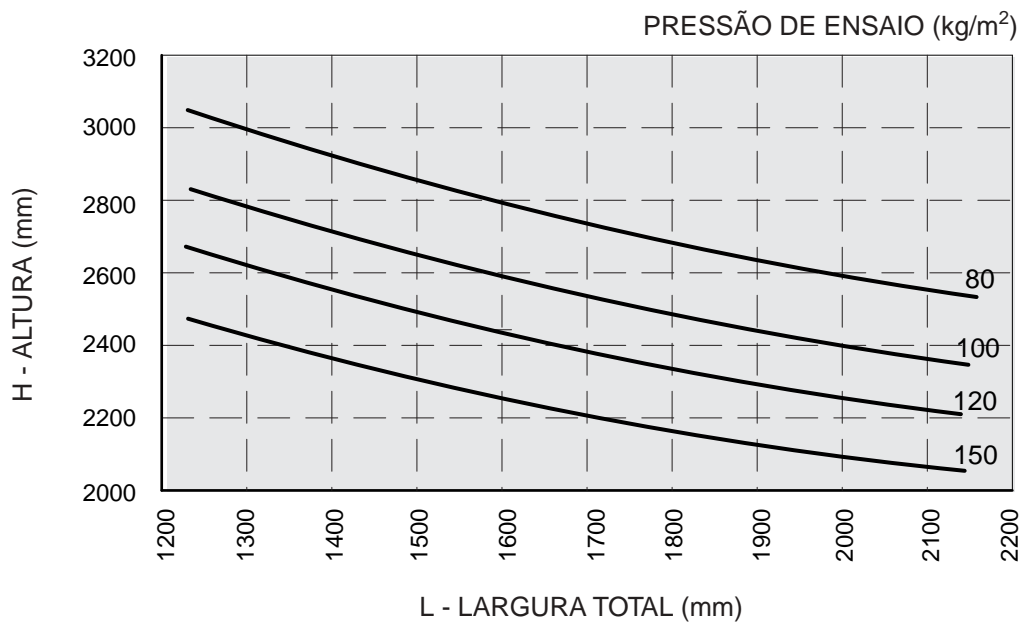

OBS.: Não ultrapassar 70kg por folha.

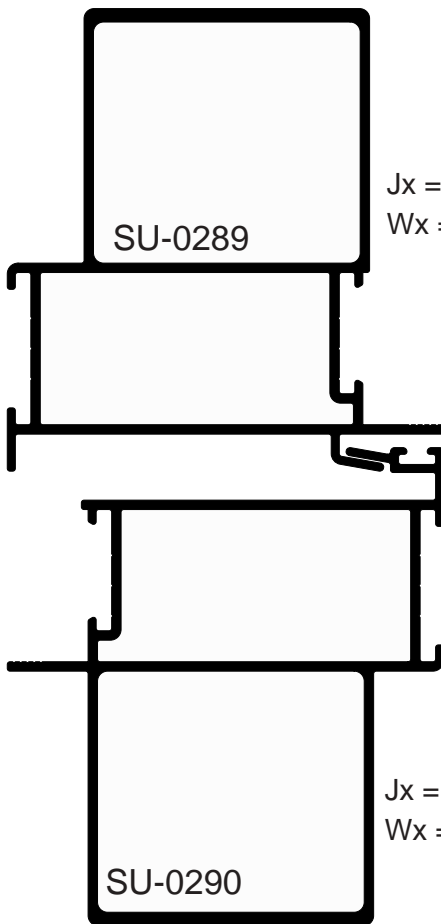

$J_x = 243\,287\text{ mm}^4$
 $W_x = 6\,862\text{ mm}^3$

$J_x = 246\,126\text{ mm}^4$
 $W_x = 6\,927\text{ mm}^3$

MÃO DE AMIGO

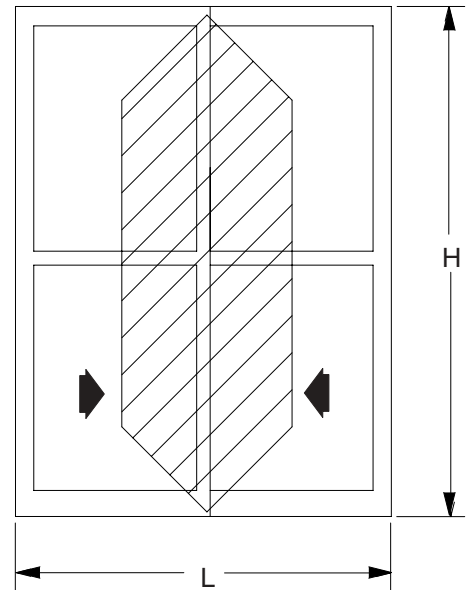

$J_{xt} = 489\,413\text{ mm}^4$
 $W_{xt} = 13\,789\text{ mm}^3$

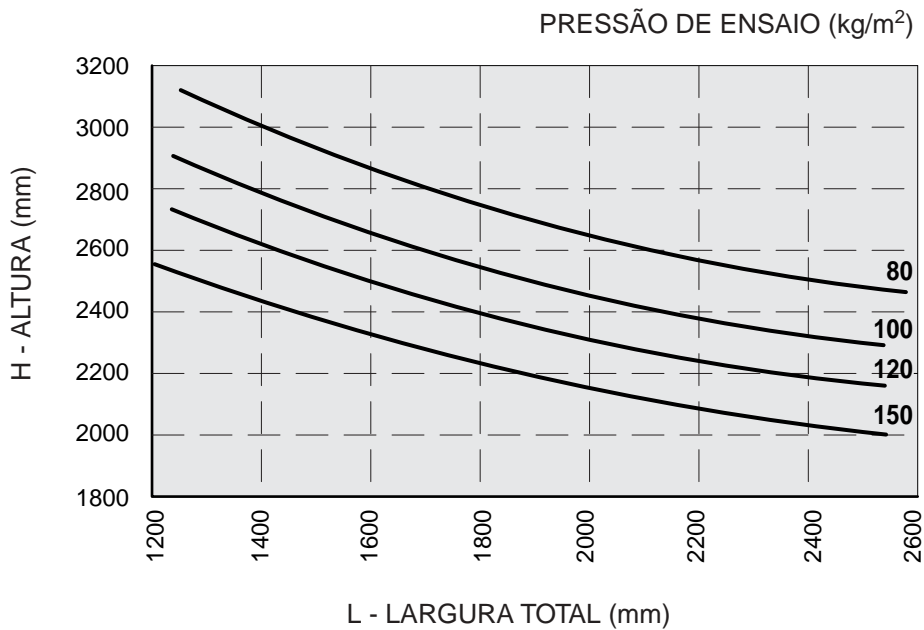

OBS.: Não ultrapassar 70kg por folha.

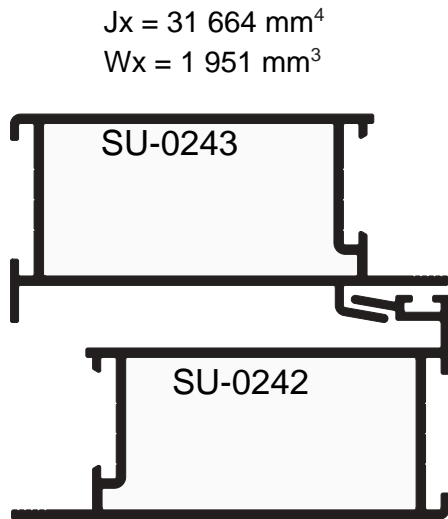

$J_x = 31\ 664\ \text{mm}^4$
 $W_x = 1\ 951\ \text{mm}^3$

$J_x = 37\ 386\ \text{mm}^4$
 $W_x = 1\ 949\ \text{mm}^3$

MÃO DE AMIGO

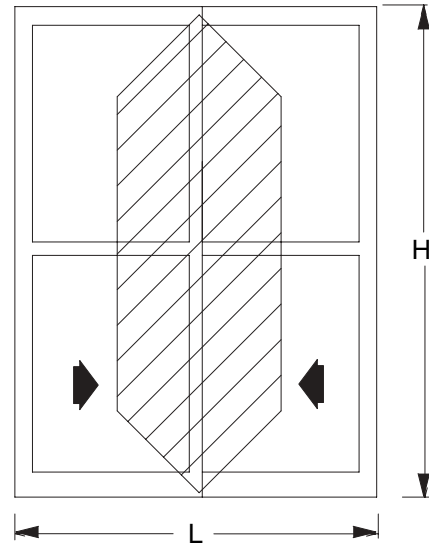

$J_{xt} = 69\ 050\ \text{mm}^4$
 $W_{xt} = 3\ 900\ \text{mm}^3$

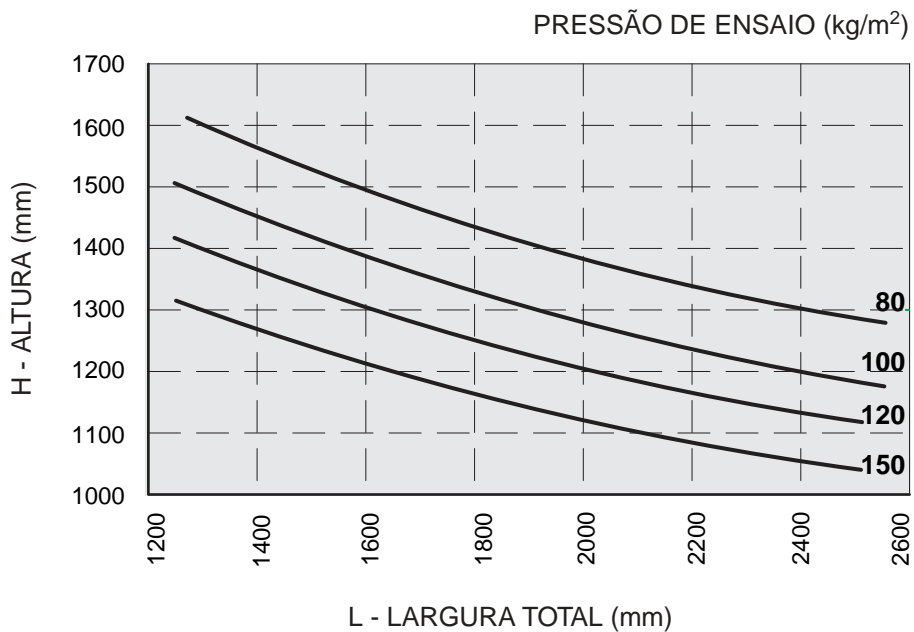

OBS.: Não ultrapassar 70kg por folha.

CENTRAL 4 FOLHAS

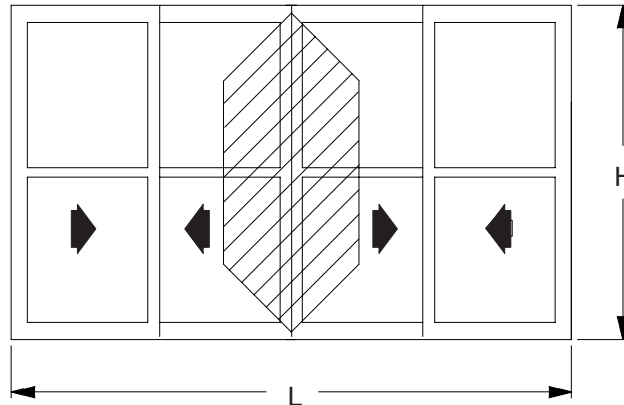

$J_{xt} = 279\,341 \text{ mm}^4$
 $W_{xt} = 9\,886 \text{ mm}^3$

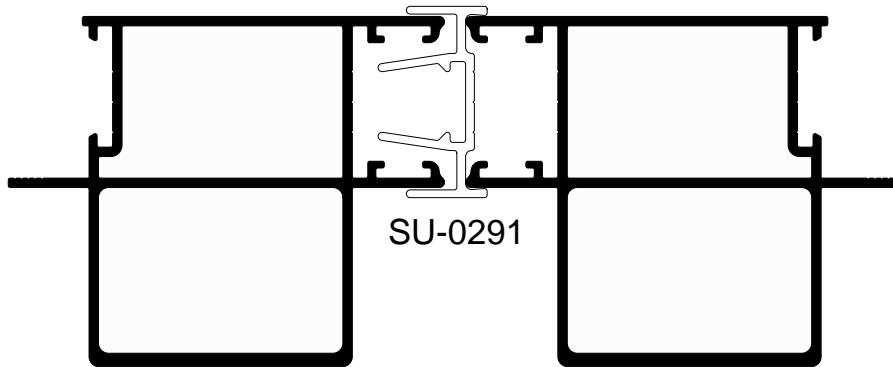

SU-0273
 $J_x = 129\,557 \text{ mm}^4$
 $W_x = 4\,791 \text{ mm}^3$

SU-0273/0291
 $J_x = 149\,784 \text{ mm}^4$
 $W_x = 5\,095 \text{ mm}^3$

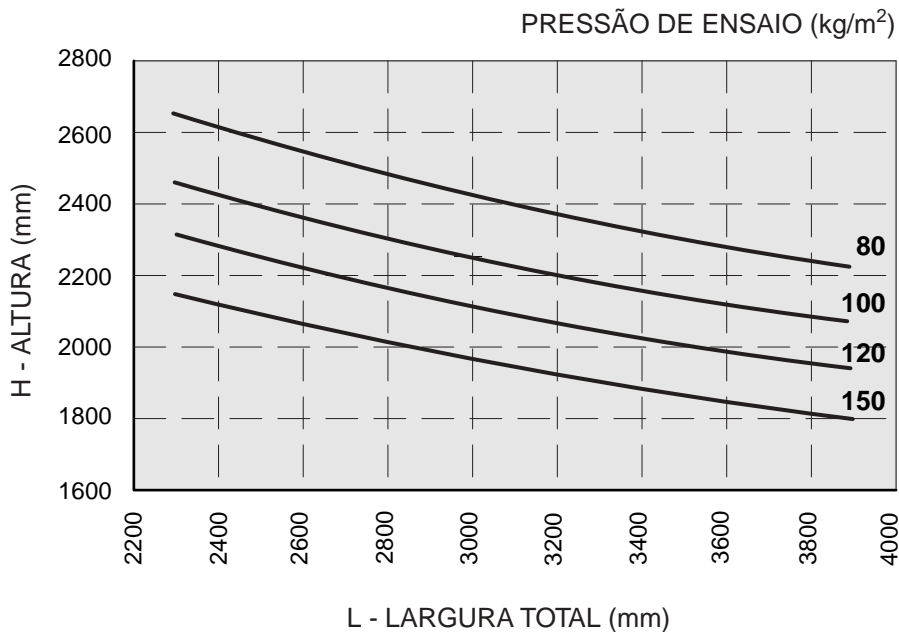

OBS.: Não ultrapassar 70kg por folha.